



BuzziTile

Product Specification Sheet

This document contains technical information about the BuzziTile



www.buzzi.space

Graphical acoustic wall element

The BuzziTile turns any blind wall into a must see. By using multiple Tiles and playing with different colours you create a highly graphical feature on the wall. Let your creativity do the work.

BuzziTile is offered in flat and different 3d pattern and can be finished off in different fabrics.

The BuzziTile family is a perfect solution for attenuating sound.

Design by BuzziSpace Studio

General



Flat | 3D

BuzziTile Square L | Square XL | Metro | Stone | Hexa | Penta | Triangle L | Triangle XL

Filling: acoustic foam



Cover: Fabric, Rough, Trevira CS + | CS, Revive 1, Revive 2, Terra, Clara 2, Remix 2, Hero, Tonus 4, Tonus Meadow, Memory 2, Matrix

Acoustics



Absorption



Diffusion

Content

Composition	3
Configurations	3
Patterns	6
Fabrics	10
Dimensions	14
Acoustics	18

Composition

Back in Felt | Tape

6 mm | 0.24" BuzziFelt
acoustic foam
layer of fabric
self adhesive tape at the back

Back in Wood | Tape

6 mm | 0.24" MDF
acoustic foam
layer of fabric
self adhesive tape at the back

Back in Wood | Powermagnets

6 mm | 0.24" MDF
acoustic foam
layer of fabric
powermagnets

Note





Be sure wall surface is free of dirt, grease or any special paint finishes that could prevent the adhesive from adhering to wall surface.

Due to possible variation in dimension and density, we advise to install the tiles with felt backing at 0,5 mm - 1 cm | 0.20" - 0.39" distance from each other. For more precise applications, tiles with wooden back are advisable.

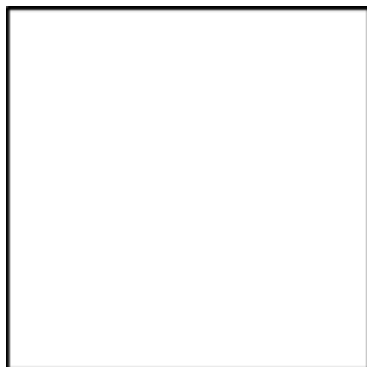
Configurations

BuzziTile Square L | XL



- Flat
-  3D: 1SQ, 4SQ, 25SQ, Arrow, Bee, Dune, Frost, Leaf, Lips, Radial, Rib, Spike, Waffle
-  Fabrics: Fabric, Rough, Trevira CS + |CS, Revive 1, Revive 2, Terra, Clara 2, Remix 2, Hero, Tonus 4, Tonus Meadow, Memory 2, Matrix
-  L: H 60 cm W 60 cm
 H 23.62" W 23.62"
- XL: H 120 cm W 120 cm
 H 47.24" W 47.24"
-  L: back in felt: ± 1kg | ± 2.20 lbs
 back in wood: ± 2 kg | ± 4.41 lbs
- XL: back in felt: ± 3,5 kg | ± 6.61 lbs
 back in wood: ± 8 kg | ± 17.64 lbs
- Flat: - back in wood | no stitch | self adhesive tape or powermagnets
- 3D: - back in felt: with or without stitch + self adhesive tape
 (no stitch for Radial | Waffle | Leaf | Bee)
- ... - back in wood: no stitch + self adhesive tape or
 no stitch + powermagnets

BuzziTile Metro

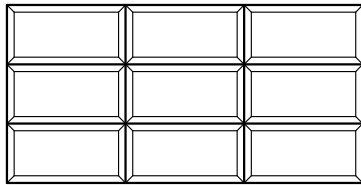

Flat
3D: Metro

Fabrics: Fabric, Rough, Trevira CS + |CS, Revive 1, Revive 2, Terra, Clara 2, Remix 2, Hero, Tonus 4, Tonus Meadow, Memory 2, Matrix

H 40 cm W 80 cm
H 15.75" W 31.50"

Back in felt: ± 1 kg | ± 2.20 lbs
Back in wood: ± 2 kg | ± 4.41 lbs

3D: - back in felt: with or without stitch + self adhesive tape
... - back in wood: no stitch + self adhesive tape or
no stitch + powermagnets

BuzziTile Stone

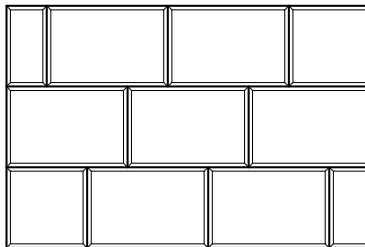

3D: Stone

Fabrics: Fabric, Rough, Trevira CS + |CS, Revive 1, Revive 2, Terra, Clara 2, Remix 2, Hero, Tonus 4, Tonus Meadow, Memory 2, Matrix

H 60 cm W 90 cm
H 23.62" W 35.43"

Back in felt: ± 1,3 kg | ± 2.87 lbs
Back in wood: ± 3 kg | ± 6.61 lbs

3D: - back in felt: no stitch + self adhesive tape
... - back in wood: no stitch + self adhesive tape or
no stitch + powermagnets

BuzziTile Hexa

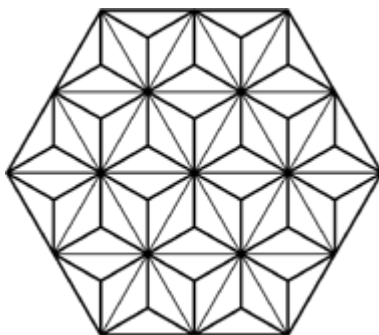

3D: Bee | Frost | Spike | Why

Fabrics: Fabric, Rough, Trevira CS + |CS, Revive 1, Revive 2, Terra, Clara 2, Remix 2, Hero, Tonus 4, Tonus Meadow, Memory 2, Matrix

H 60 cm W 69,3 cm
H 23.62" W 27.28"

Back in felt: ± 0,75 kg | ± 1.65 lbs
Back in wood: ± 1,75 kg | ± 3.86 lbs

3D: - back in felt: no stitch + self adhesive tape
... - back in wood: no stitch + self adhesive tape or
no stitch + powermagnets

BuzziTile Penta

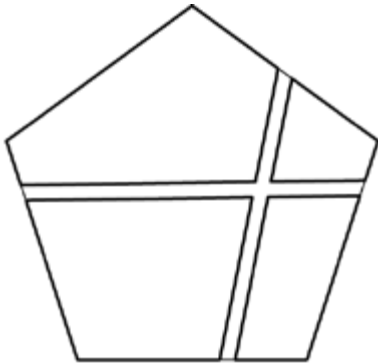

📍 3D: Kite

🌲 Fabrics: Fabric, Rough, Trevira CS + |CS, Revive 1, Revive 2, Terra, Clara 2, Remix 2, Hero, Tonus 4, Tonus Meadow, Memory 2, Matrix

✂ H 60 cm W 63 cm
H 23.62" W 24.80"

⚖ Back in felt: ± 0,70 kg | ± 1.54 lbs
Back in wood: ± 1,50 kg | ± 3.31 lbs

3D: - back in felt: no stitch + self adhesive tape
... - back in wood: no stitch + self adhesive tape or
no stitch + powermagnets

BuzziTile Triangle L | XL

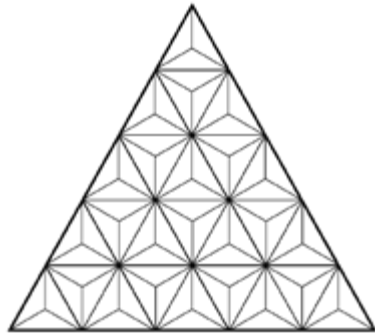

📍 Flat
3D: Spike

🌲 Fabrics: Fabric, Rough, Trevira CS + |CS, Revive 1, Revive 2, Terra, Clara 2, Remix 2, Hero, Tonus 4, Tonus Meadow, Memory 2, Matrix

✂ L: H 52 cm W 60 cm
H 20.47" W 23.62"
XL: H 104 cm W 120 cm
H 40.94" W 47.24

⚖ L: Back in felt: ± 0,5kg | ± 1.10 lbs
Back in wood: ± 1 kg | ± 2.20 lbs
XL: Back in felt: ± 1,5kg | ± 3.31 lbs
Back in wood: ± 4 kg | ± 8.82 lbs

Flat: - back in wood | no stitch | self adhesive tape or powermagnets
3D: - back in felt: no stitch + self adhesive tape
... - back in wood: no stitch + self adhesive tape or
no stitch + powermagnets

Patterns

BuzziTile Square L

Flat

H 60 cm W 60 cm
H 23.62" W 23.62"



1SQ

H 60 cm W 60 cm
H 23.62" W 23.62"

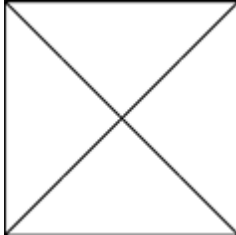

4SQ

H 60 cm W 60 cm
H 23.62" W 23.62"

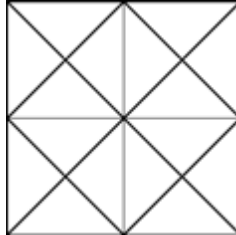

25SQ

H 60 cm W 60 cm
H 23.62" W 23.62"

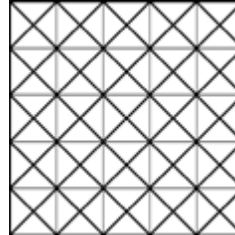

Arrow

H 60 cm W 60 cm
H 23.62" W 23.62"

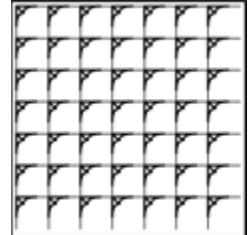

Bee

H 60 cm W 60 cm
H 23.62" W 23.62"

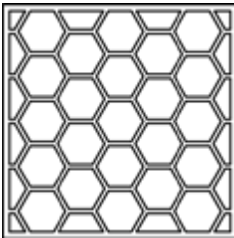

Dune

H 60 cm W 60 cm
H 23.62" W 23.62"

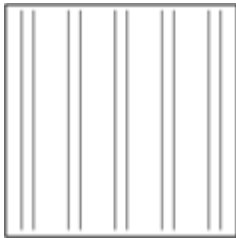

Frost

H 60 cm W 60 cm
H 23.62" W 23.62"

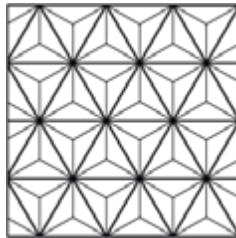

Leaf

H 60 cm W 60 cm
H 23.62" W 23.62"

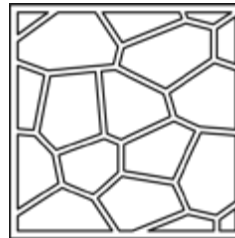

Lips

H 60 cm W 60 cm
H 23.62" W 23.62"

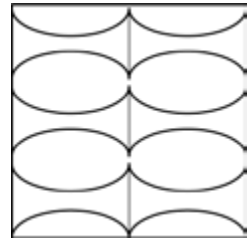

Radial

H 60 cm W 60 cm
H 23.62" W 23.62"

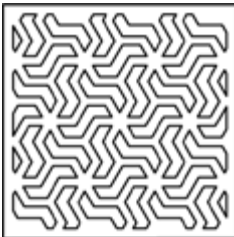

Rib

H 60 cm W 60 cm
H 23.62" W 23.62"



Spike

H 60 cm W 60 cm
H 23.62" W 23.62"

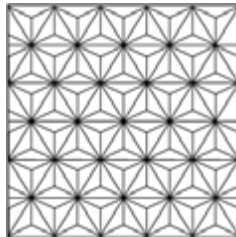

Waffle

H 60 cm W 60 cm
H 23.62" W 23.62"

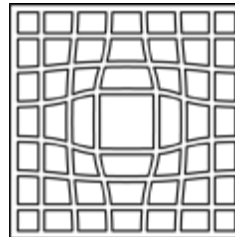

BuzziTile Square XL

Flat

H 120 cm W 120 cm
H 47.24" W 47.24"

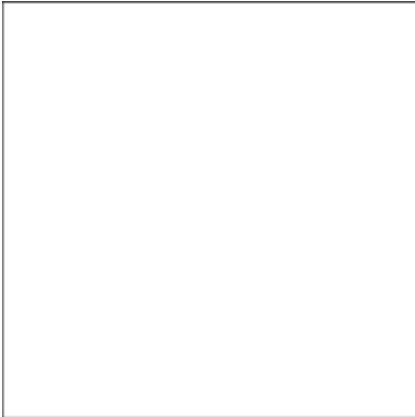

4SQ

H 120 cm W 120 cm
H 47.24" W 47.24"

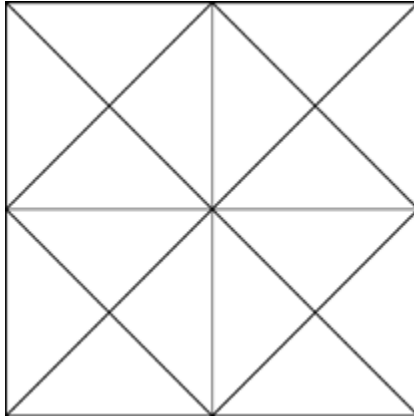

16SQ

H 120 cm W 120 cm
H 47.24" W 47.24"

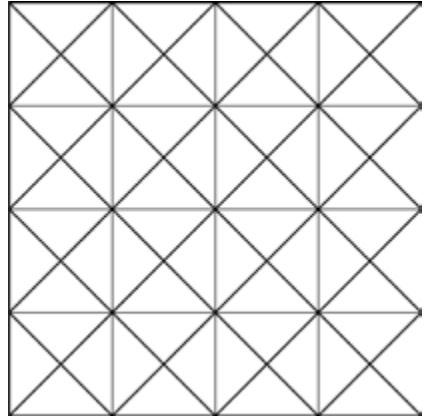

100SQ

H 120 cm W 120 cm
H 47.24" W 47.24"

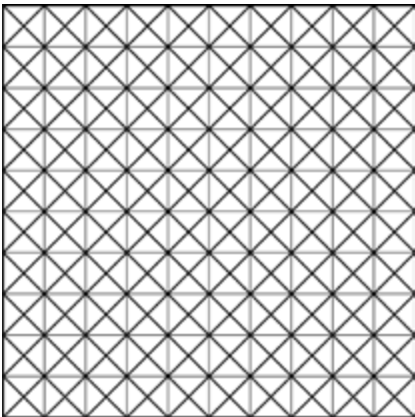

Arrow

H 120 cm W 120 cm
H 47.24" W 47.24"

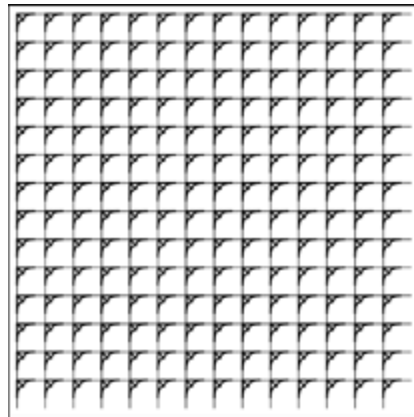

Bee

H 120 cm W 120 cm
H 47.24" W 47.24"

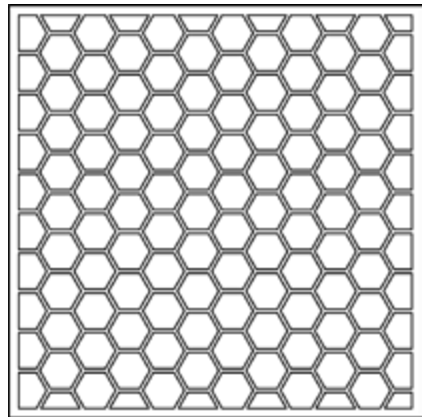

Dune

H 120 cm W 120 cm
H 47.24" W 47.24"

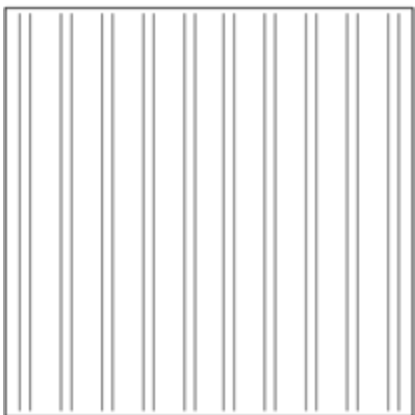

Frost

H 120 cm W 120 cm
H 47.24" W 47.24"

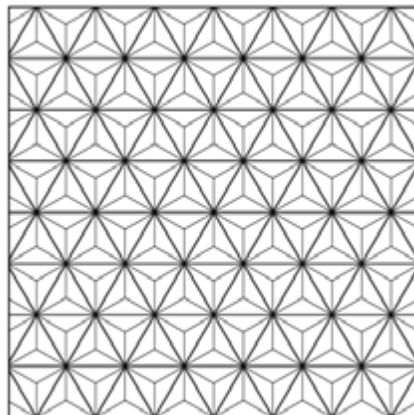

Leaf

H 120 cm W 120 cm
H 47.24" W 47.24"

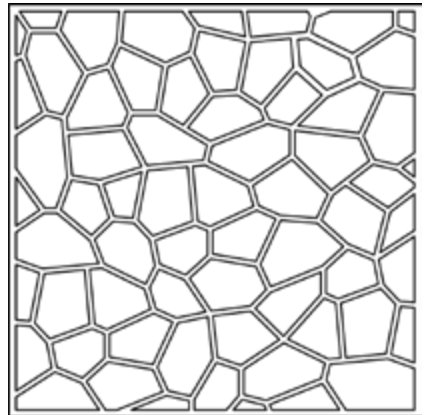

Lips

H 120 cm W 120 cm
H 47.24" W 47.24"

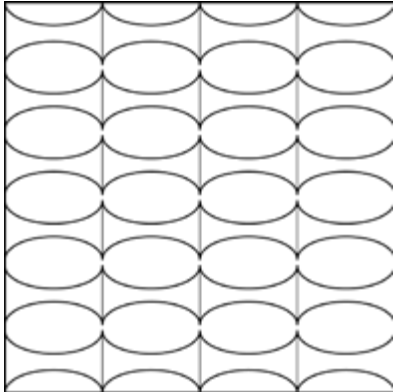

Radial

H 120 cm W 120 cm
H 47.24" W 47.24"

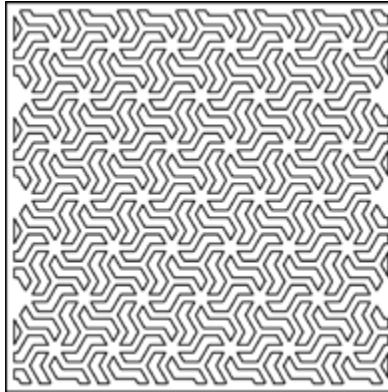

Rib

H 120 cm W 120 cm
H 47.24" W 47.24"

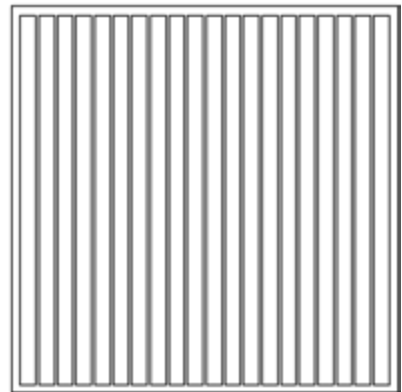

Spike

H 120 cm W 120 cm
H 47.24" W 47.24"

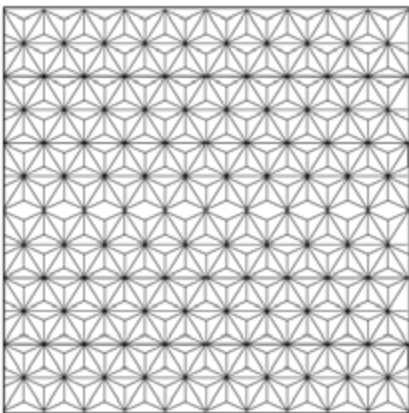

Waffle

H 120 cm W 120 cm
H 47.24" W 47.24"

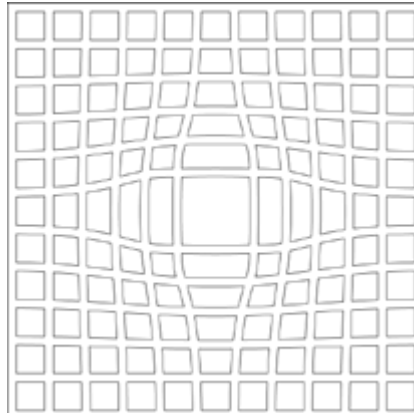

BuzziTile Metro

Flat

H 40 cm W 80 cm
H 15.75" W 31.50"

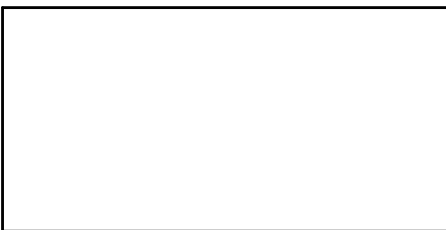

3D Metro

H 40 cm W 80 cm
H 15.75" W 31.50"

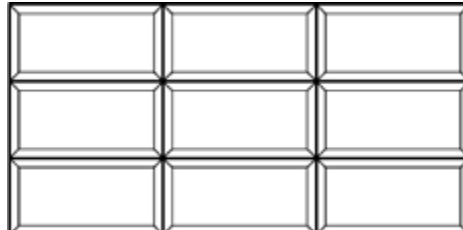

BuzziTile Stone

H 60 cm W 90 cm
H 23.62" W 35.43"

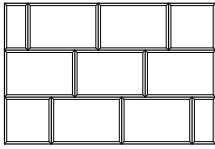

BuzziTile Hexa

Bee

H 60 cm W 69,3 cm
H 23.62" W 27.28"

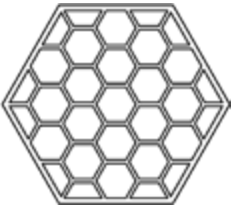

Frost

H 60 cm W 69,3 cm
H 23.62" W 27.28"

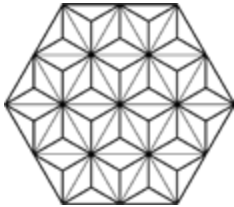

Spike

H 60 cm W 69,3 cm
H 23.62" W 27.28"

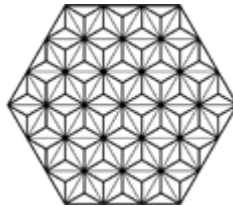

Why

H 60 cm W 69,3 cm
H 23.62" W 27.28"



BuzziTile Penta

Kite

H 60 cm W 63 cm
H 23.62" W 24.80"

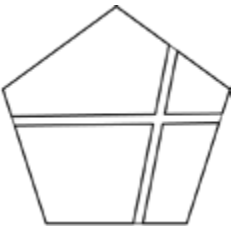

BuzziTile Triangle L | XL

Flat

W 60 cm H 52 cm
W 23.62" H 20.47"



Spike

W 60 cm H 52 cm
W 23,62" H 20.47"

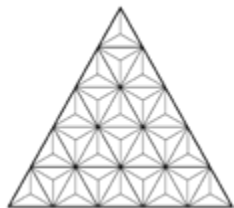

Flat

W 120 cm H 104 cm
W 47.24 H 40.94"

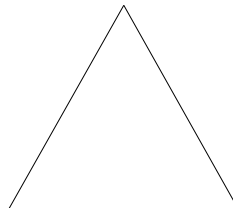

Spike

W 120 cm H 104 cm
W 47.24 H 40.94"

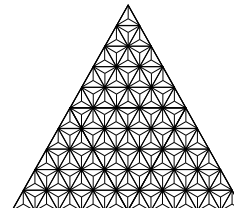

Fabrics

Fabric

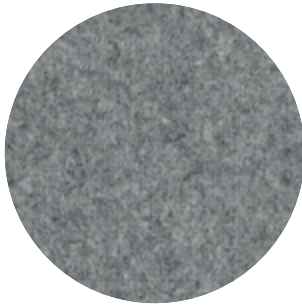

Category A

Composition 70% Recycled Wool, 25% Recycled Polyacryl,
5% Recycled Other Fabrics

Weight 405 g/m² | 11.94 oz/yd²

Abrasion resistance 40.000 Martindale, 50,000 Wyzenbeek

Flammability EU: EN 1021.1/2006 | BS EN 1021.1/2006 (cigarette).
EN 1021.2/2006 | BS EN 1021.2/2006 (match)
USA: CAL TB 117 | ASTM E84 CLASS A

Fastness to light EU: 4 | USA 4

Fastness to rubbing EU: Wet 3-4 | Dry 4-5

Fastness to crocking USA: Wet 5 | Dry 5



Rough

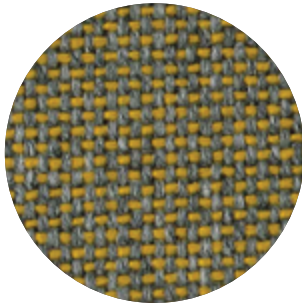

Category A

Composition 100% Polyacryl

Weight 456 g/m² | 13.45 oz/yd²

Abrasion resistance 40.000 Martindale

Flammability EU: EN 1021.1/2006 | BS EN 1021.1/2006 (cigarette)
USA: CAL TB TB 117

Fastness to light EU: 5

Fastness to rubbing EU: Wet: 3 | Dry: 3



Trevira CS+ | CS

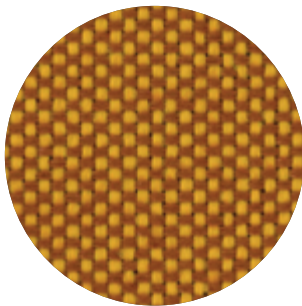

Category A

Weight 420 g/m² | 12.39 oz/yd²

Composition 100% Polyester, Trevira CS

Abrasion resistance 100.000 Martindale, 90,000 Wyzenbeek

Flammability BS 5852 part II: CRIB 5 | BS 7176 Medium Hazard
USA: CAL TB 117 | M1 | B1 | EN 1021/1-2 | C1 |
IMO Res. A652 (16)

Fastness to light EU: 6 | USA 5

Fastness to rubbing EU: Wet 4-5 | Dry 4-5

Fastness to crocking USA: Wet 5 | Dry 5



Revive 1

kvadrat

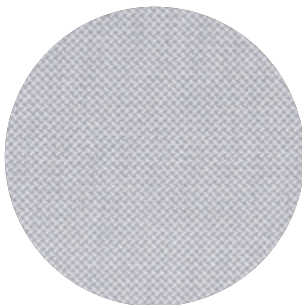

Category A

Composition 100% recycled polyester FR

Weight 430 g/lin.m

Abrasion resistance 60.000 Martindale rubs, EN ISO 12947

Flammability EN 1021-1/2 | DIN 4102 B1 | Önorm B1/Q1
UNI 9175 1IM | US Cal. Tech. Bull. 117
IMO A.652 (16)

Fastness to light Note 5-7, ISO 105-B02

Fastness to rubbing (ISO) dry 5, wet 4-5

Pilling Note 4-5, EN ISO 12945



Revive 2

kvadrat

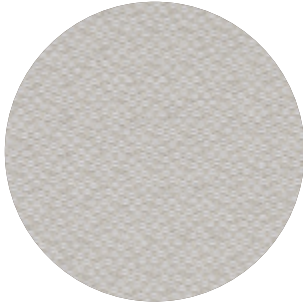

Category A

Composition 100% recycled polyester FR

Weight 420 g/lin.m

Abrasion resistance 45.000 Martindale rubs, EN ISO 12947

Flammability EN 1021-1/2 | DIN 4102 B1 | Önorm B1/Q1
UNI 9175 1IM | US Cal. Tech. Bull. 117
IMO A.652 (16)

Fastness to light Note 5-7, ISO 105-B02

Fastness to rubbing (ISO) dry 5, wet 4-5

Pilling Note 4-5, EN ISO 12945



Terra

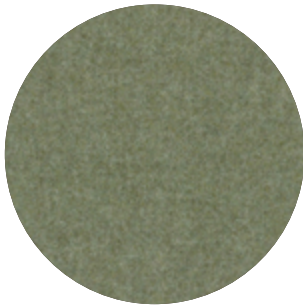

Category B

Composition 100% Pure New Wool

Weight 370 g/m² | 10.91 oz/yd²

Abrasion resistance 40.000 Martindale, 25,000 Wyzenbeek

Flammability EU: BS5852 CRIB 5 | BS5867 PART 2 : 2008 : TYPE B
EN: 1021.2/2006 | USA: CAL TB 117

Fastness to light EU 5 | USA 5

Fastness to rubbing EU: Wet 4 | Dry 4

Fastness to crocking USA: Wet 4 | Dry 4



Clara 2

kvadrat

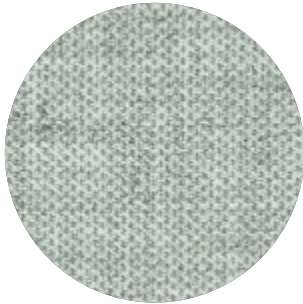

Category B

Composition 92% new wool, 8% nylon

Weight 400 g/lin.m

Abrasion resistance 80.000 Martindale rubs, EN ISO 12947

Flammability EN 1021-1/2 | BS 5852, ignition source 2-3 | DIN 4102 B2
NF D 60 013 | UNI 9175 1IM | US Cal. Tech. Bull. 117, Sec. E
NFPA 260 | IMO A.652(16)

Fastness to light Note 5-7, ISO 105-B02

Fastness to rubbing (ISO) dry 4-5, wet 4

Pilling Note 4, EN ISO 12945



Remix 2

kvadrat



Category B

Composition 90% new wool, 10% nylon

Weight 415 g/lin.m

Abrasion resistance 100.000 Martindale rubs, EN ISO 12947

Flammability EN 1021-1/2 | BS 5852 part 1
Önorm B1/Q1 | NF D 60 013 | UNI 9175, 1IM
AS/NZS 1530.3 | Cal. Tech. Bull. 117-2013
NFPA 260 | IMO FTP Code 2010:Part 8

Fastness to light Note 5-7, ISO 105-B02

Fastness to rubbing (ISO) dry 4-5, wet 4

Pilling Note 4, EN ISO 12945



Hero

kvadrat

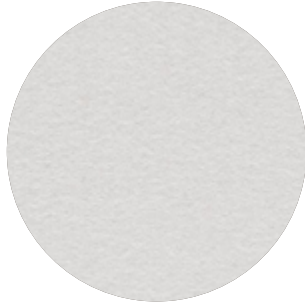

Category C

Composition 96% new wool, 4% nylon

Weight 580 g/lin.m

Abrasion resistance 45.000 Martindale rubs, EN ISO 12947

Flammability EN 1021-1/2 | DIN 4102 B2 | NF D 60 013
UNI 9175 11M | US Cal. Bull. 117-2013 | NFPA 260
IMO A.652 (16)

Fastness to light Note 5-6, ISO 105-B02

Fastness to rubbing (ISO) dry 4-5, wet 4-5

Pilling Note 3-4, EN ISO 12945



Tonus 4

kvadrat



Category D

Composition 90% new wool, 10% Helanca

Weight 665 g/lin.m

Abrasion resistance 100.000 Martindale rubs, EN ISO 12947

Flammability EN 1021-1/2 | BS 5852 part 1 | DIN 4102 B2
Önorm B1/Q1 | NF D 60 013 | UNI 9175 11M
US Cal. Bull. 117-2013 | NFPA 260 | IMO A.652 (16)

Fastness to light Note 5-7, ISO 105-B02

Fastness to rubbing (ISO) dry 3-5, wet 3-5

Pilling Note 3, EN ISO 12945



Tonus Meadow

kvadrat

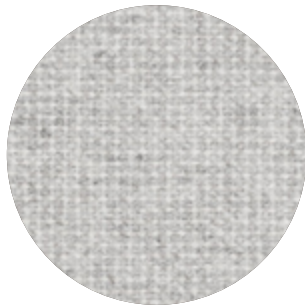

Category D

Composition 90% new wool, 10% Helanca

Weight 665 g/lin.m

Abrasion resistance 100.000 Martindale rubs, EN ISO 12947

Flammability EN 1021-1/2 | BS 5852 part 1 | DIN 4102 B2
Önorm B1/Q1 | NF D 60 013 | UNI 9175 11M
US Cal. Bull. 117-2013 | NFPA 260 | IMO A.652 (16)

Fastness to light Note 5-7, ISO 105-B02

Fastness to rubbing (ISO) dry 4-5, wet 4

Pilling Note 3, EN ISO 12945



Memory 2

kvadrat



Category E

Composition 100% Trevira CS

Weight 700 g/lin.m

Abrasion resistance

35.000 rubs acc. to the Martindale method, EN ISO 12947

Flammability EN 1021-1/2 | DIN 4102 B1 | Önorm B1/Q1
NF D 60 013 | NF P 92 507 M1 | UNI 9175 11M
UNI 9177 classe 1 | US Cal. Tech. Bull. 117
IMO A.652 (16)

Fastness to light Note 5-8, ISO 105-B02

Fastness to rubbing (ISO) dry 4-5, wet 4-5

Pilling Note 4, EN ISO 12945





Category F

Composition 100% Trevira CS

Weight 760 g/lin.m

Abrasion resistance

App. 60.000 rubs acc. to the Martindale method, EN ISO 12947

Flammability EN 1021-1/2 | BS 5852 crib 5 | BS 5867 part 2 type B

DIN 4102 B1 | Önorm B1/Q1 | NF D 60 013

UNI 9175 1IM | US Cal. Tech. Bull. 117 | NFPA 701

IMO A.652 (16)

Fastness to light Note 5-7, ISO 105-B02

Fastness to rubbing (ISO) dry 4-5, wet 4-5

Pilling Note 4, EN ISO 12945



Dimensions

BuzziTile Square L

Front

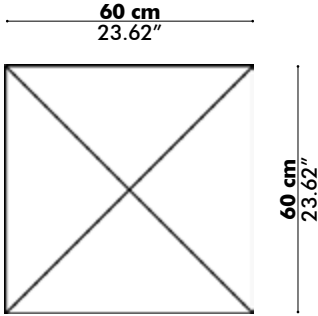

Thickness

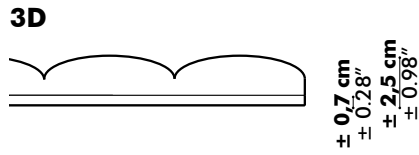

Flat

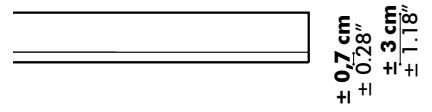

Back with powermagnets

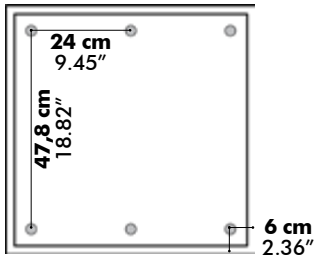

Positive | negative magnet location

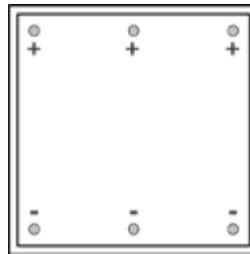

Back with self adhesive tape

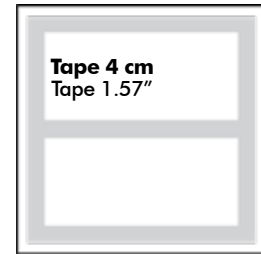

BuzziTile Square XL

Front

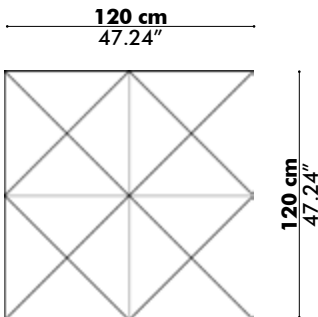

Thickness

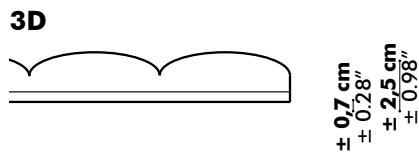

Flat

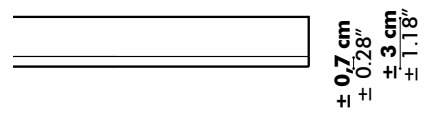

Back with powermagnets

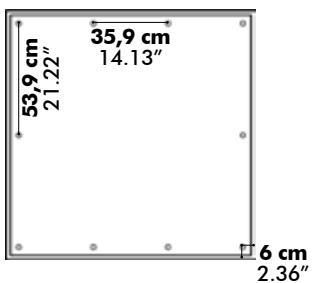

Positive | negative magnet location

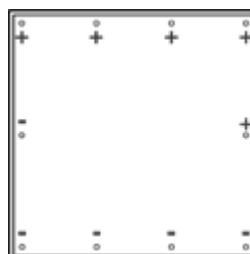

Back with self adhesive tape

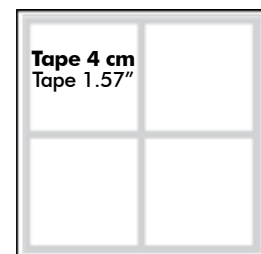

BuzziTile Metro

Front

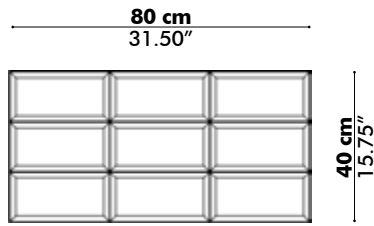

Thickness

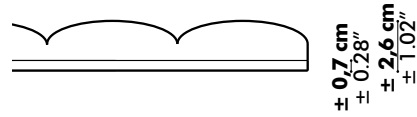

Back with powermagnets

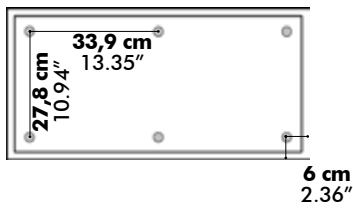

Positive | negative magnet location



Back with self adhesive tape



BuzziTile Stone

Front

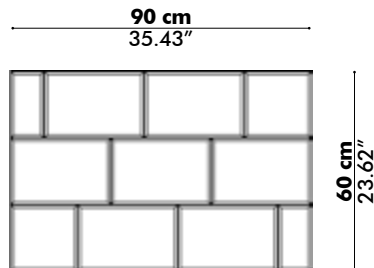

Thickness

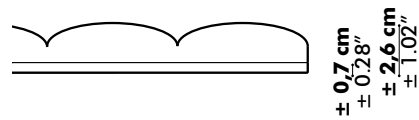

Back with powermagnets

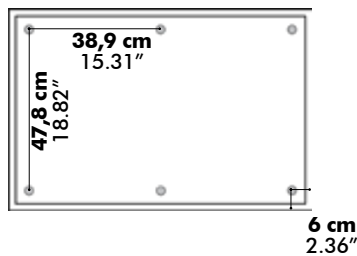

Positive | negative magnet location



Back with self adhesive tape

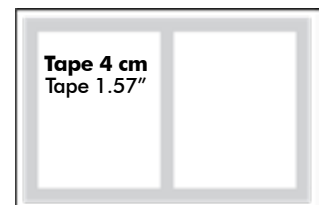

BuzziTile Hexa

Front

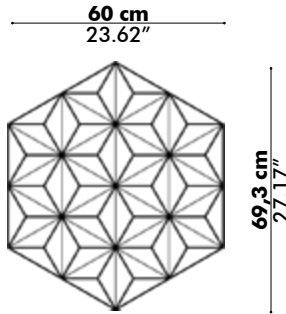

Thickness

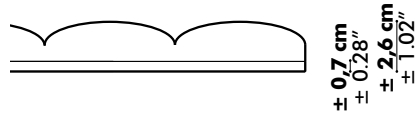

Back with powermagnets

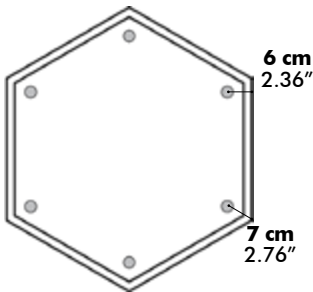

Positive negative magnet location

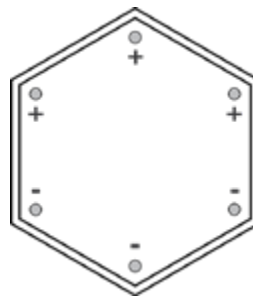

Back with self adhesive tape



BuzziTile Penta

Front

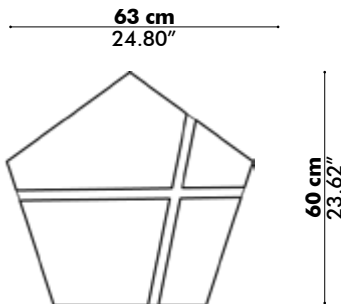

Thickness

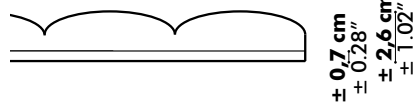

Back with powermagnets

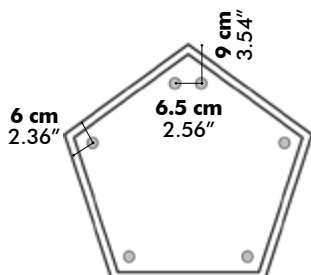

Positive negative magnet location

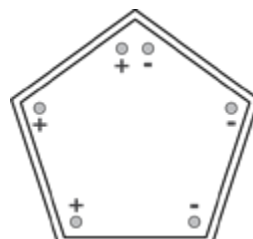

Back with self adhesive tape



BuzziTile Triangle L

Front

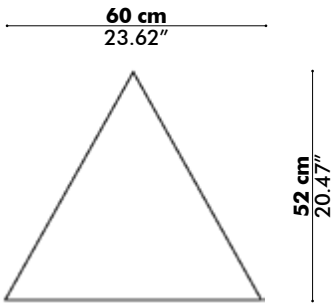

Thickness

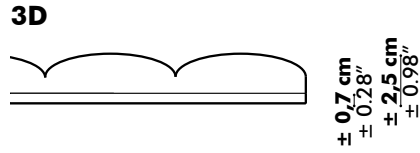

Flat

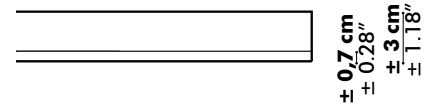

Back with powermagnets

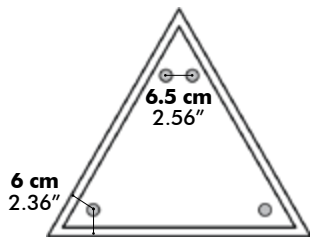

Positive negative magnet location

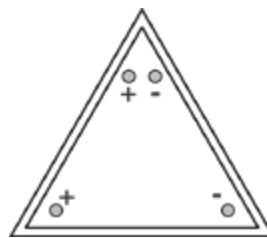

Back with self adhesive tape

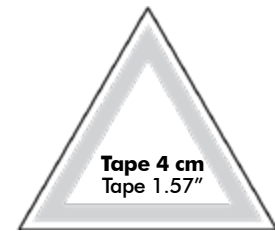

BuzziTile Triangle XL

Front

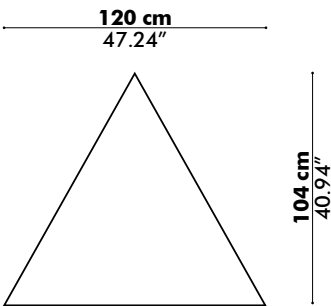

Thickness

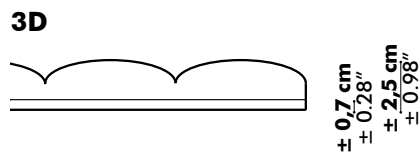

Flat

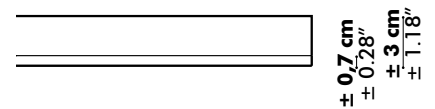

Back with powermagnets

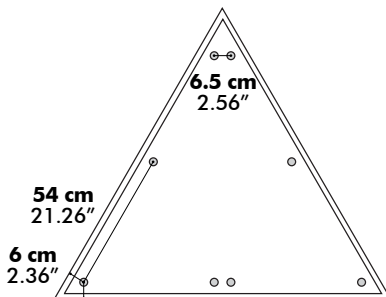

Positive negative magnet location

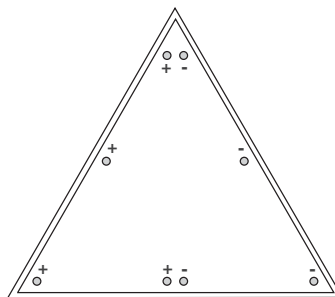

Back with self adhesive tape

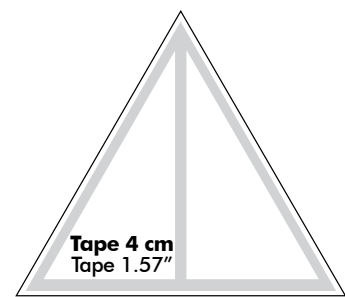

Acoustics

BuzziTile

Absorption coefficient

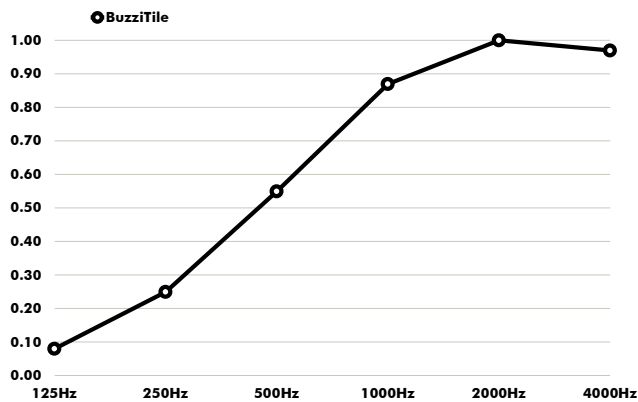

Hz	α^s
125	0.08
250	0.25
500	0.55
1000	0.87
2000	1.04
4000	0.97

Absorption values

α_w (ISO 11654) **0.55**

NRC (ASTM - C423) **0.70**

SAA (ASTM-C423) **0.68**

Class (ISO 11654) **D**

Glossary

All calculations are based on accredited lab measurements, official document available on www.Buzzi.Space

Definitions

α	Weighted absorption coefficient	(ISO 11654)
NRC	Noise reduction coefficient	(ASTM - C423)
SAA	Sound absorption average	(ASTM - C423)

Classification of sound absorbers NEN-EN-ISO 11654

A	0.90 0.95 1.0
B	0.80 0.85
C	0.60 0.65 0.70 0.75
D	0.03 0.55
E	0.15 0.25