

# PRODUCT FACT SHEET

## E27 LAMP FURNITURE / LIGHTING / ACCESSORIES

**Mattias Ståhlbom on the design** "The simplicity of the naked bulb is hard to compete with. It stands for something that feels romantic and contemporary at the same time. E27 departs from the essence of a lamp - the socket - creating a simple yet strong object that celebrates the potential beauty in simplicity."

PROCESS	E27 is pressed in vulcanised silicone rubber under high temperature. The cord is extruded. Inside socket and cord is assembled by hand.
DESIGNED BY / YEAR OF DESIGN	Mattias Ståhlbom / 2008
TYPE	Pendant light
LAMP DESCRIPTION	E27 can be used as a single light source, in pairs, rows or even in clusters to create a modern Scandinavian chandelier.
ENVIRONMENT	Indoor
MATERIAL	Silicone/rubber, plastic socket and PVC cord.
COLOUR / REF. CODE	Dark grey, white, yellow, red, green, purple, black, blue, light grey, light green, rose, orange
CANOPY / BALDAKIN	Non. Offered separately.
VOLTAGE (V)	18W E27 halogen bulb. 220-240V, energy class C with average lifespan of 1800 hours. 40W E27 Normal bulb. 220-230V, energy class E with average lifespan of 1500 hours.
CORD LENGTH (MM)	4000 mm - Longer cord is available for projects, contact <a href="mailto:contractsales@muuto.com">contractsales@muuto.com</a>
BULB INCLUDED	Yes
WEIGHT (KG)	0,6
CLEANING INSTRUCTIONS	Clean with soft dry cloth only. Always switch off the electricity supply before cleaning.
ABOUT THE DESIGNER	Mattias Ståhlbom is an internationally successful architect and partner at the Stockholm-based architecture and design studio TAF. TAF's aim is to make ordinary life less ordinary through subtle but effective changes in how products and architecture appear and function. Mattias Ståhlbom's products have been exhibited at prestigious venues such as MOMA NY and the Swedish National Museum in Stockholm.

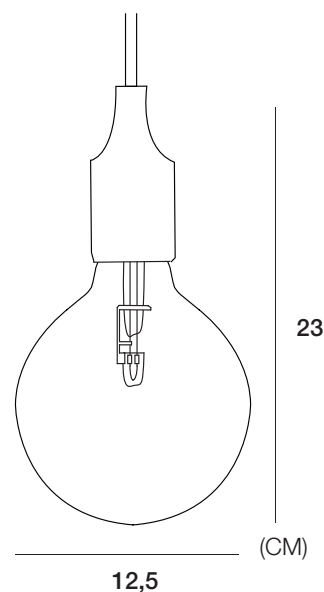

### CERTIFICATIONS



# E 27 BY MATTIAS STÅHLBOM ASSEMBLY INSTRUCTION

## CONTENT:

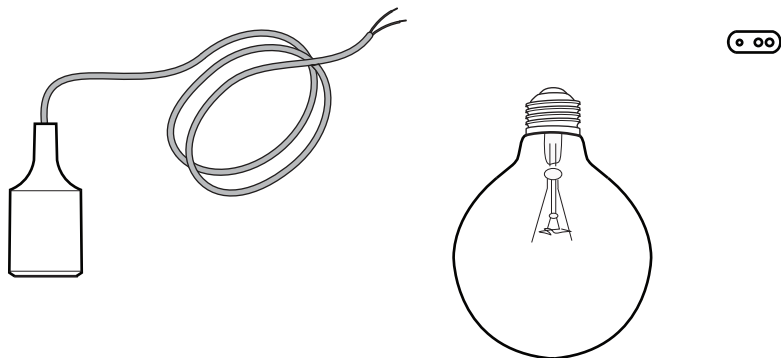

## ACCESSORY BOX:



NOT INCLUDED  
can be purchased separately

## ASSEMBLY INSTRUCTION:

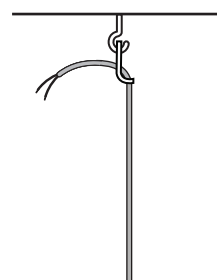
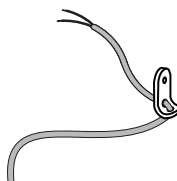
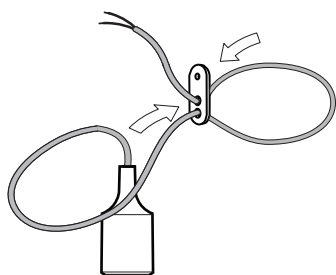
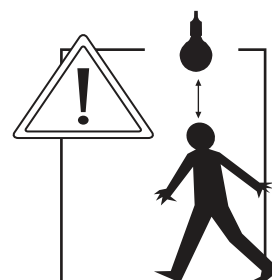
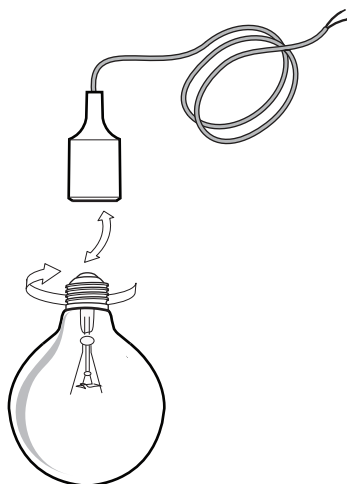
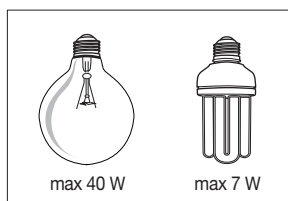

# MUUTO LAMP CEILING CAPS

## STUDIO

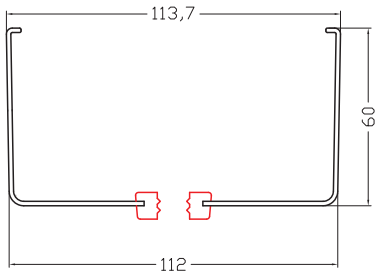

BALDAKIN FOR STUDIO

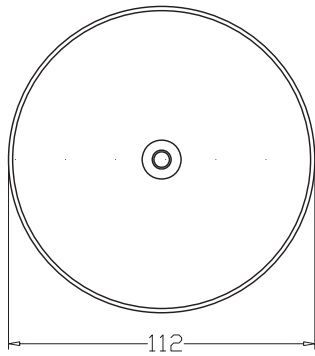

## E27

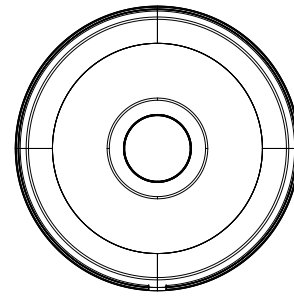
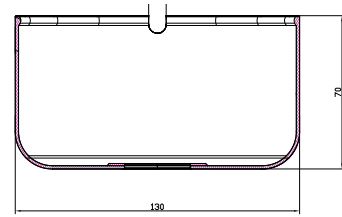

## PLUGGED

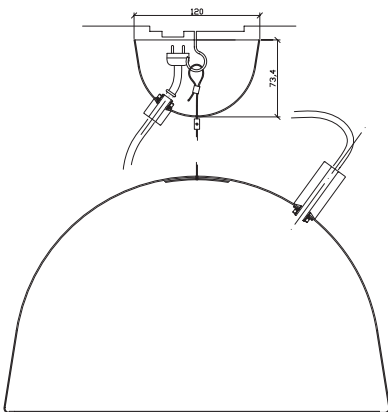
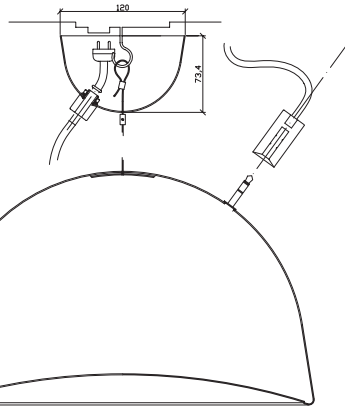

## MULTIPLE

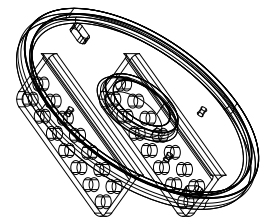
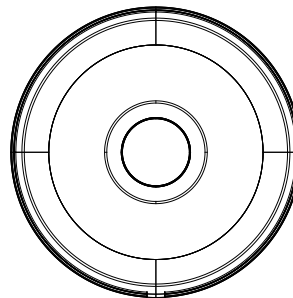
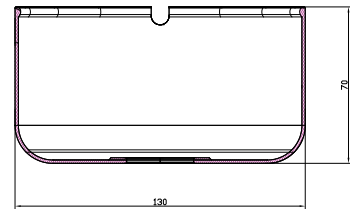

# Assembly Instruction sheet

